

LMP

CZ	PŮDNÍ SCHODY	LV	BĒNIŅU KĀPNES
DE	BODENTREPPE	NL	ZOLDER/VLIERINGTRAP
EE	PÕÕNINGUREDEL	PL	SCHODY STRYCHOWE
ES	ESCALERAS ESCAMOTEABLES	PT	ESCADA DE SOTAO-ENCAIXADA
FR	ESCALIER ESCAMOTABLE	RO	SCARĂ MODULARĂ
GB	LOFT LADDER	RU	ЧЕРДАЧНАЯ ЛЕСТНИЦА
HU	PADLÁSFELJÁRÓ LÉPCSŐ	SI	PODSTREŠNE SLOPLJIVE STOPNICE
IT	LE SCALE PER LA SOFFITTA	SK	STROPNÉ SKLÁPACIE SCHODY
LT	PALĖPĖS LAIPTELIAI	UA	СХОДИ НА ГОРИЦЕ



<http://www.fakro.com/download/film-installation-instructions/loft-ladders/>

READ SAFETY INSTRUCTION BEFORE USING



NC 9CE



**WARNING! ACHTUNG!
UWAGA! ATTENTION!
CUIDADO! ПРИМЕЧАНИЕ!**

CZ Montáž schodů je nutno provést v souladu s návodem. POZOR! Použití schodů v rozporu s návodem je zakázáno, může způsobit vážnou nehodu a má za následek ztrátu záruky a odpovědnosti výrobce.

DE Die Montage und Nutzung der Bodentreppe sollte gemäß der Anleitung durchgeführt werden. ACHTUNG! Die Nichtbeachtung der Anleitung ist verboten und kann schwere Unfälle verursachen und ist aus der Garantie ausgeschlossen. Der Hersteller übernimmt keine Verantwortung.

EE Põhninguluugi paigaldus ja kasutamine peab olema vastavuses lisatud juhenditega. TÄHELEPANU! Juhistele mitte vastav kasutamine on rangelt keelatud kuna võib põhjustada tõsise õnnetuse, see tühistab garantiid ning muudab Tootja toote eest enam mitte vastutavaks.

ES La instalación y el uso de las escaleras se debe ejecutar de acuerdo con el manual de instrucciones. ¡PRECAUCIÓN! Está prohibida la utilización de la escalera que no sea conforme con el manual de instrucciones, porque puede causar un accidente grave, deshabilita la garantía y hace que el fabricante no se responsabilice.

FR L'installation et l'utilisation des escaliers doivent être effectuées conformément à l'instruction. ATTENTION! L'utilisation des escaliers contrairement à l'instruction est interdite, elle peut provoquer un accident grave, annulation de la garantie et manque de responsabilité du fabricant.

GB Installation and use of the loft ladder should be strictly in accordance with included instructions. CAUTION! Using the loft ladder in violation of the instructions is strictly forbidden, may result in a serious injury, will invalidate the Warranty and makes the Manufacturer no longer liable for the product.

HU A padlásfeljáró lépcső beépítése és üzemeltetése a beépítési/használati útmutató szerint kell, hogy történjen! FIGYELEM! A padlásfeljáró lépcső útmutatóval ellentétes vagy azzal nem megegyező módon történő használata tilos és balesetveszélyes, illetve súlyos balesettel járhat valamint garanciavesztést eredményez; a fentiekből adódó következményekért a gyártó nem vállal semmiféle felelősséget.

IT L'installazione e l'uso va fatto nel pieno rispetto delle istruzioni. ATTENZIONE! è assolutamente vietato l'utilizzo difforme alle istruzioni d'uso dato che può essere causa di gravi incidenti ed in ogni caso fa decadere la garanzia nonché qualsiasi responsabilità del produttore.

LT Montuojant ir naudojantis palėpės laiptais būtina laikytis nurodytų instrukcijų. ĮSPĖJIMAS: naudotis palėpės laiptais pažeidžiant instrukcijas griežtai draudžiama, nes tai gali sukelti rimtą nelaimingą atsitikimą, ir gamintojas turi teisę panaikinti garantiją ir nebeatsakyti už gaminį.

LV Bēniņu kāpņu uzstādīšana un lietošana veicama atbilstoši pievienotajām instrukcijām. UZMANĪBU! Kāpņu lietošana neatbilstoši instrukcijas prasībām ir stingri aizliegta, jo tā var izraisīt nopietnus nelaimes gadījumus, kā arī pārtrauc noteikto garantijas apkalpošanu un ražotāja atbildību par produktu.

NL Het is noodzakelijk dat montage en gebruik van de zoldertrappen conform de handleidingen uitgevoerd worden. LET OP! Gebruik van de zoldertrap is niet toegestaan wanneer deze niet conform de handleiding is gemonteerd. Dit kan gevaarlijke situaties veroorzaken. De garantie wordt in dit geval niet toegekend en de producent is niet verantwoordelijk voor de mogelijke gevolgen.

PL Montaż i użytkowanie schodów należy wykonywać zgodnie z instrukcją. UWAGA! użytkowanie schodów niezgodnie z instrukcją jest zabronione, może spowodować groźny wypadek, wyłącza gwarancję oraz powoduje brak odpowiedzialności producenta.

PT A instalação e o uso da escada devem ser de acordo com as instruções incluídas. ATENÇÃO! O uso da escada violando as instruções é estritamente proibido, pois isso pode causar um acidente grave, anula a Garantia e torna o Fabricante não responsável pelo produto.

RO Instalarea și utilizarea scârilor trebuie efectuate conform instrucțiunilor. ATENȚIE! Încălcarea acestor instrucțiuni este interzisă deoarece duce la pierderea garanției și poate provoca accidente grave. Producătorul nu își asumă răspunderea pentru evenimentele produse ca urmare a încălcării instrucțiunilor de instalare și utilizare a scârilor.

RU Монтаж и эксплуатация лестницы должны проводиться согласно инструкциям производителя. ВНИМАНИЕ! Неправильная эксплуатация лестницы может привести к несчастному случаю, отменить гарантию производителя и снять с него ответственность.

SI Nameštitev in uporaba podstrešja morajo biti v skladu z vključenimi navodili. OPOZORILO! Uporaba lestve podvozja v nasprotju z navodili je strogo prepovedana, saj lahko povzroči resno nesrečo, razveljavi garancijo in povzroči, da proizvajalec ne odgovarja več za izdelek.

SK Montáž a používanie schodov je potrebné vykonávať v súlade s návodom. POZOR! Používanie schodov v rozpore s návodom je zakázané, môže spôsobiť vážnu nehodu a má za následok stratu záruky a zodpovednosti výrobcu.

US Installation and use of the attic ladder should be in accordance with included instructions. WARNING! Using the attic ladder in violation of the instructions is strictly forbidden as it may cause a serious accident, it voids the Warranty and makes the Manufacturer no longer liable for the product.

2

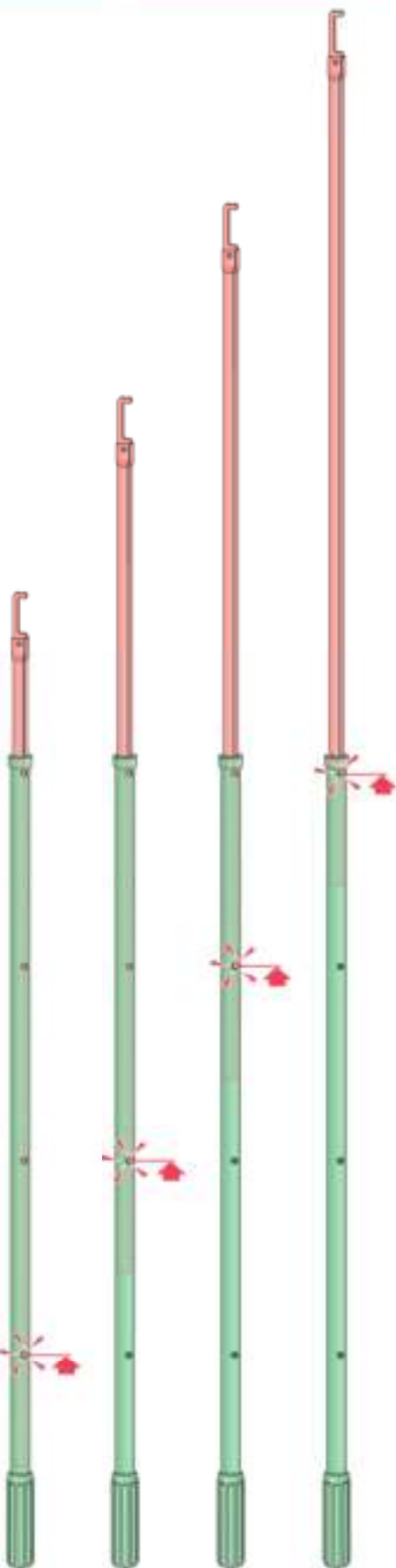
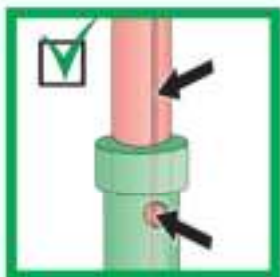

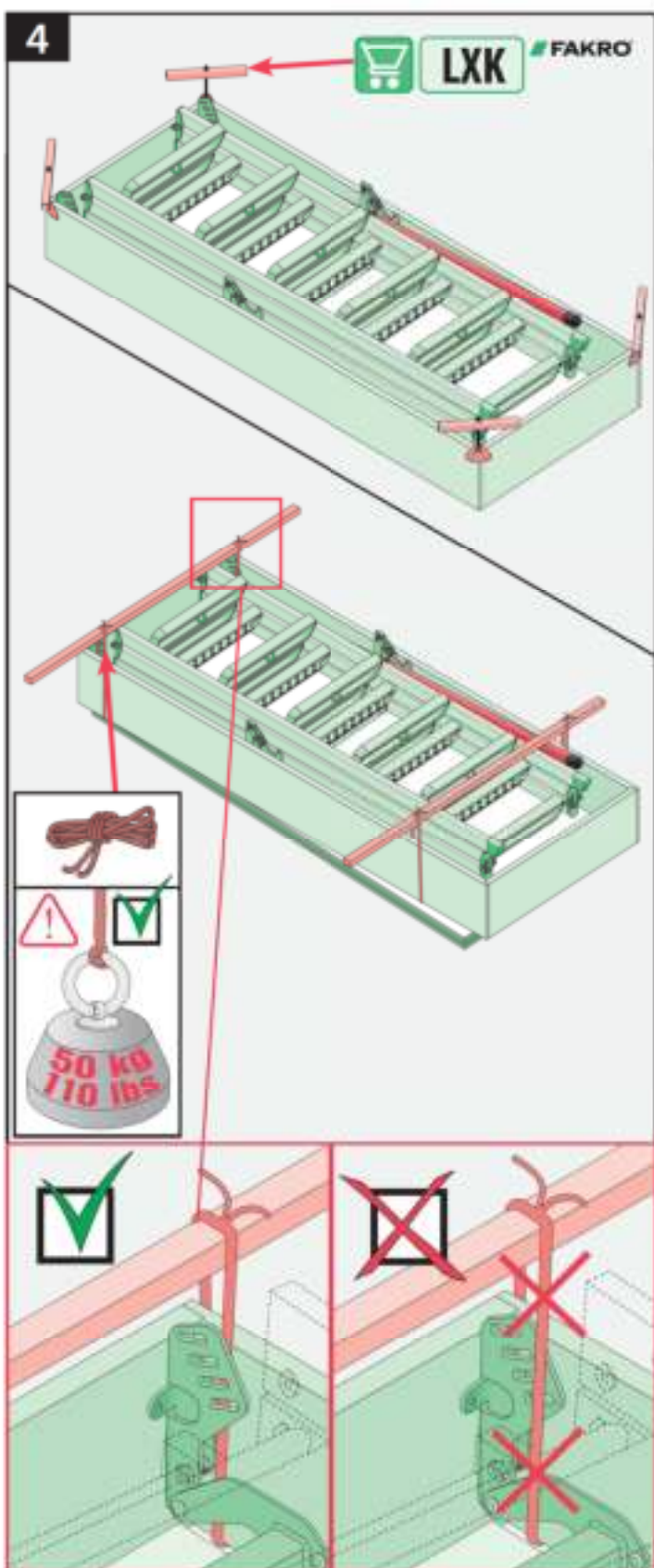
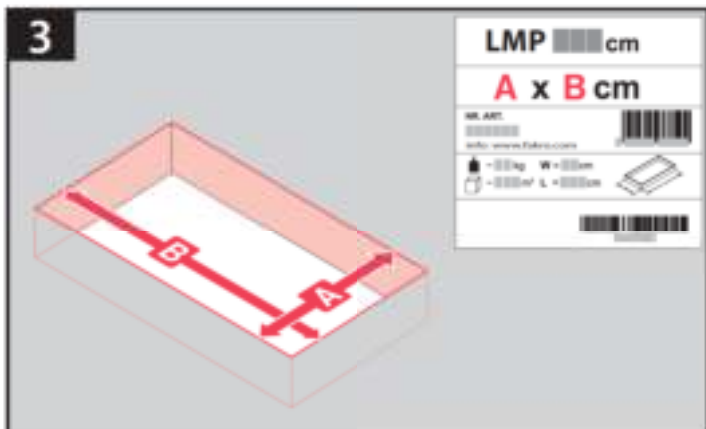

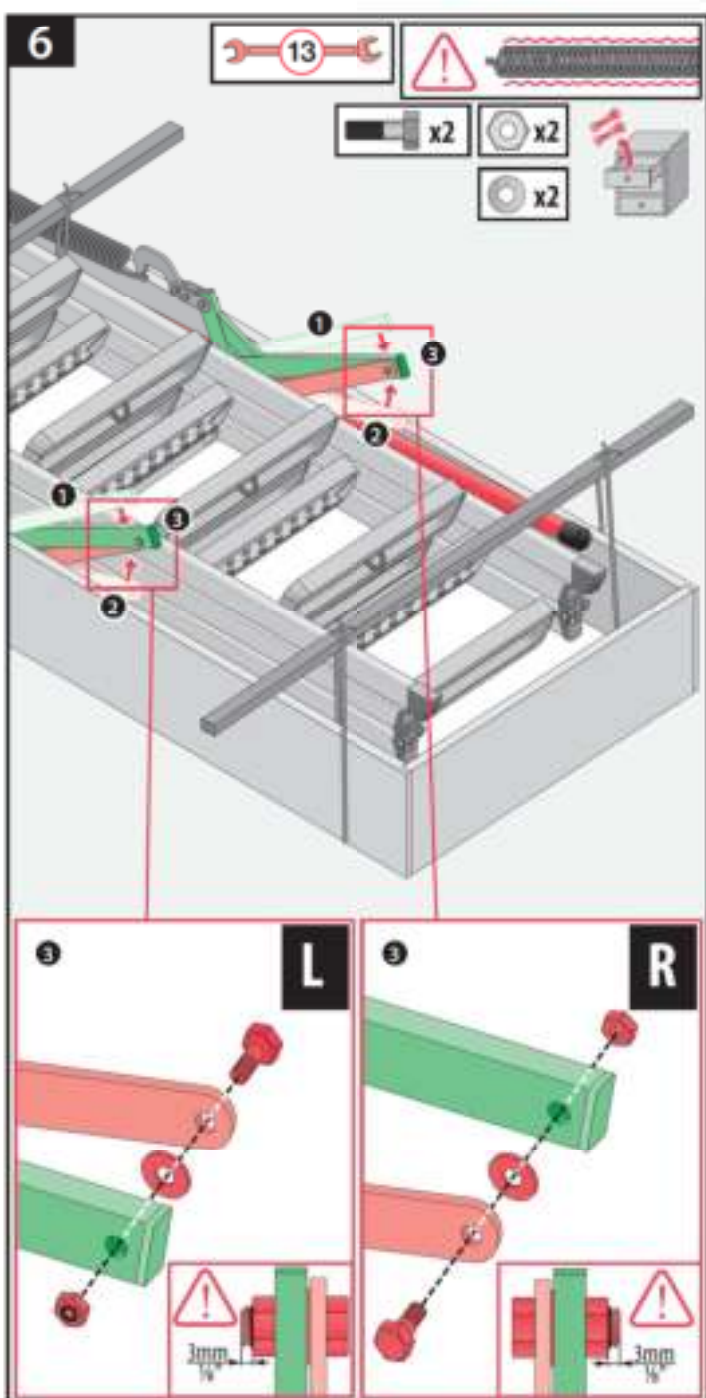
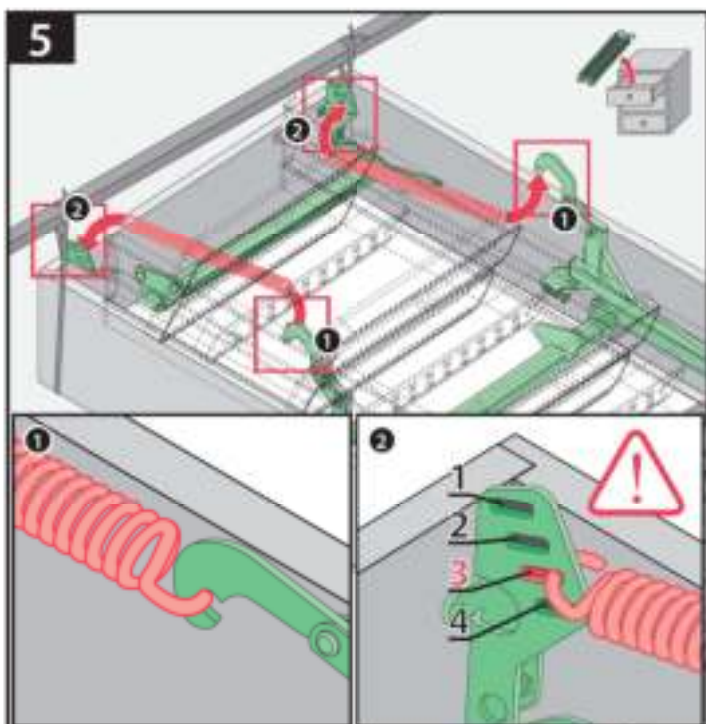

7a

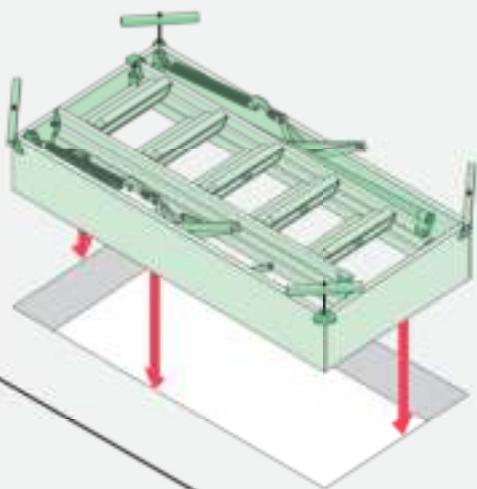

NC 99L

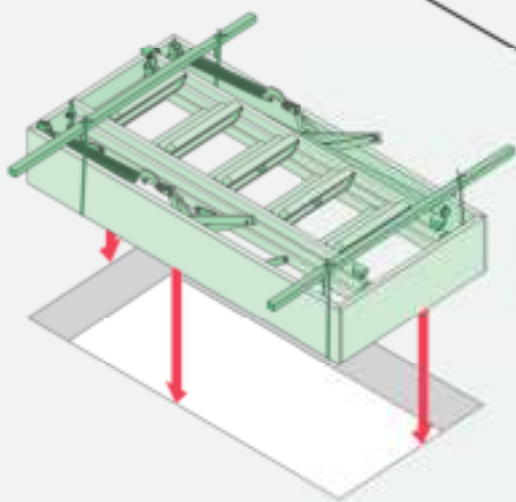

7b

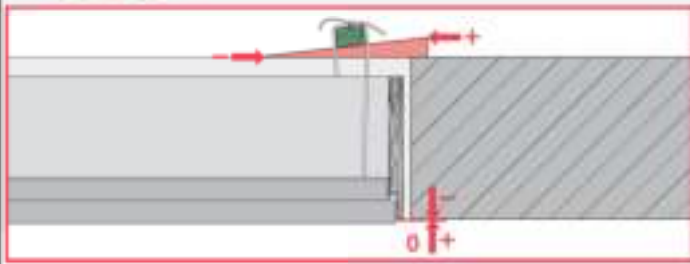
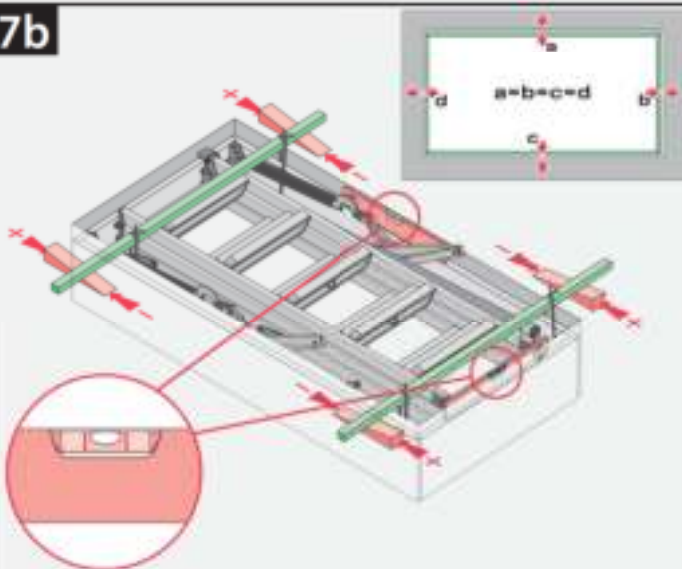

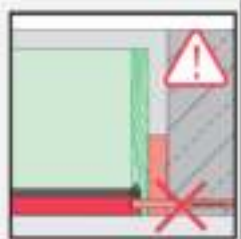
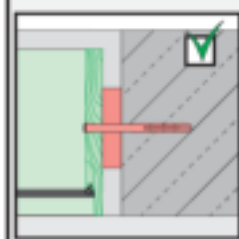
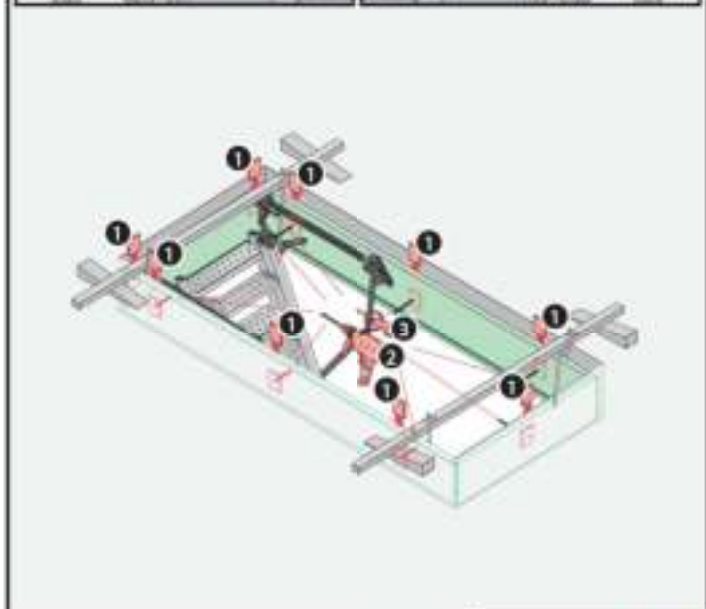
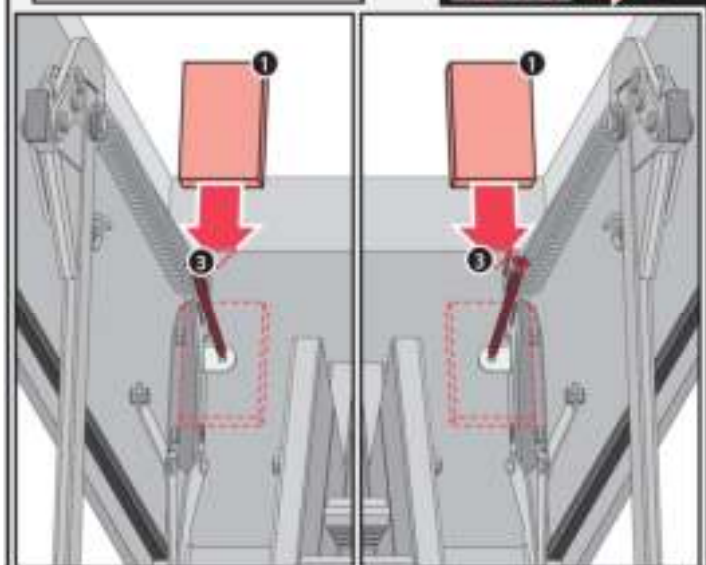

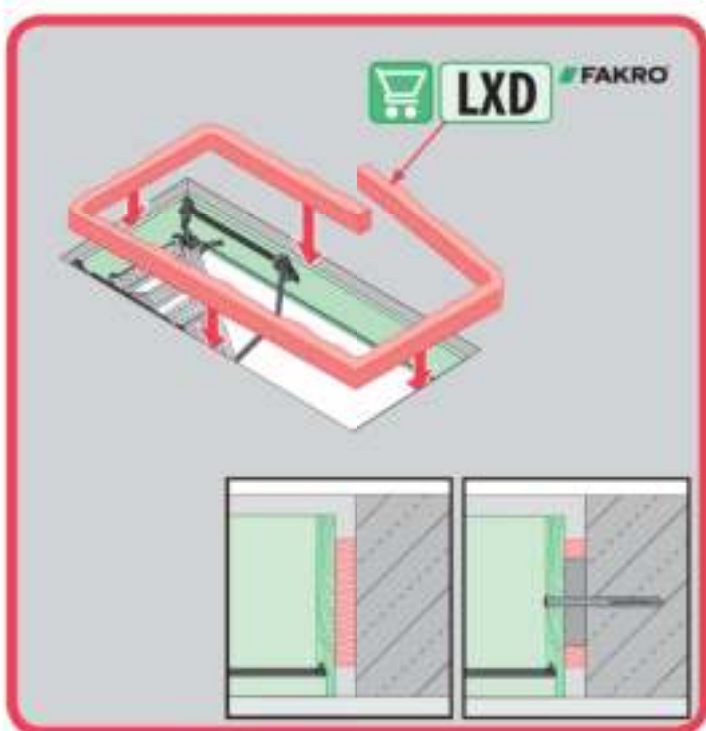
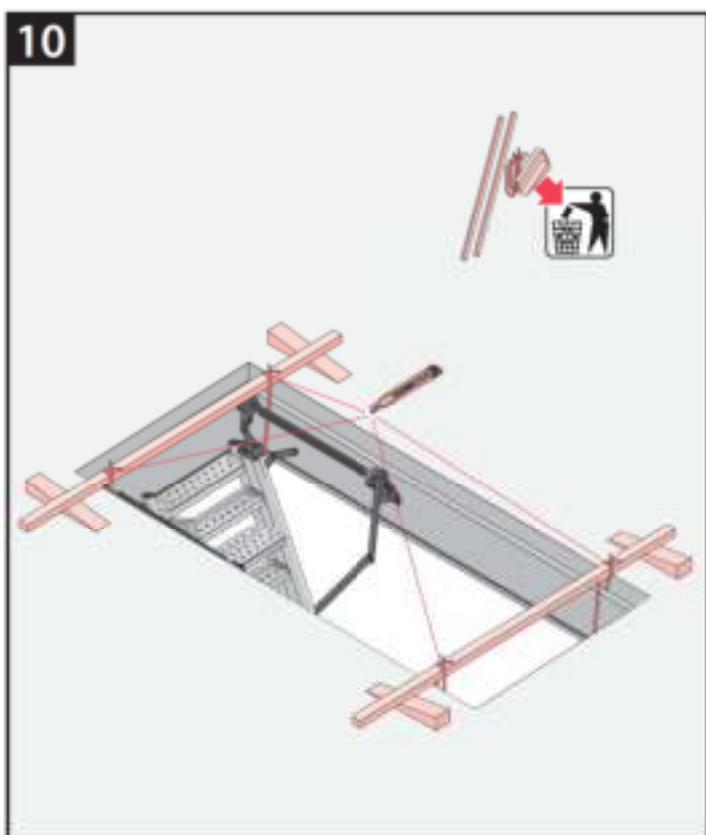
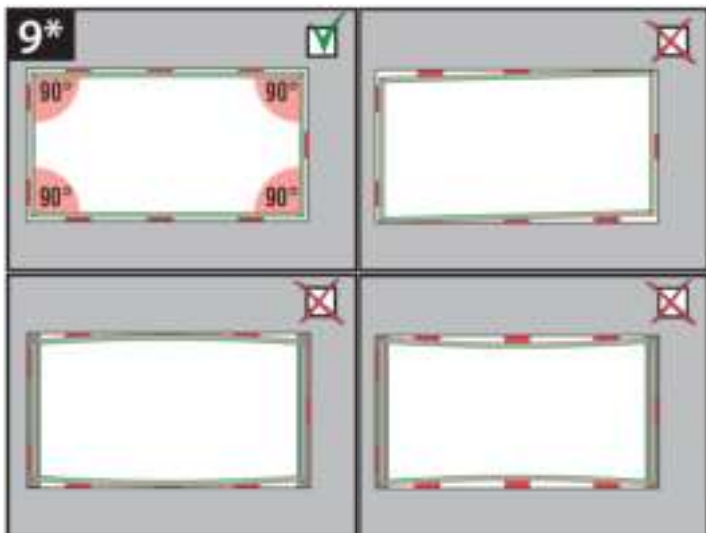

11a

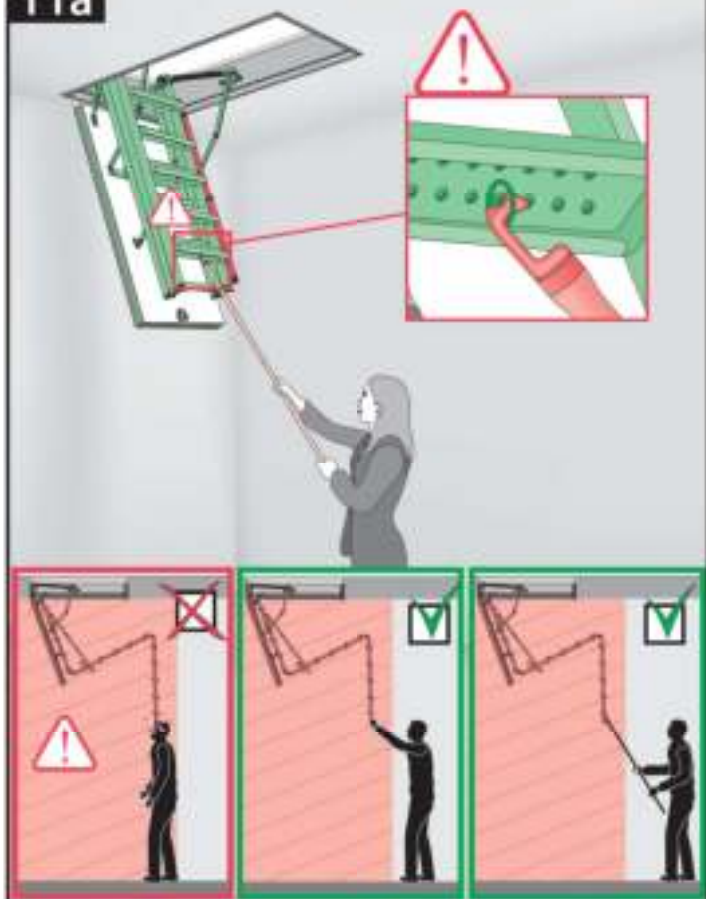

11b

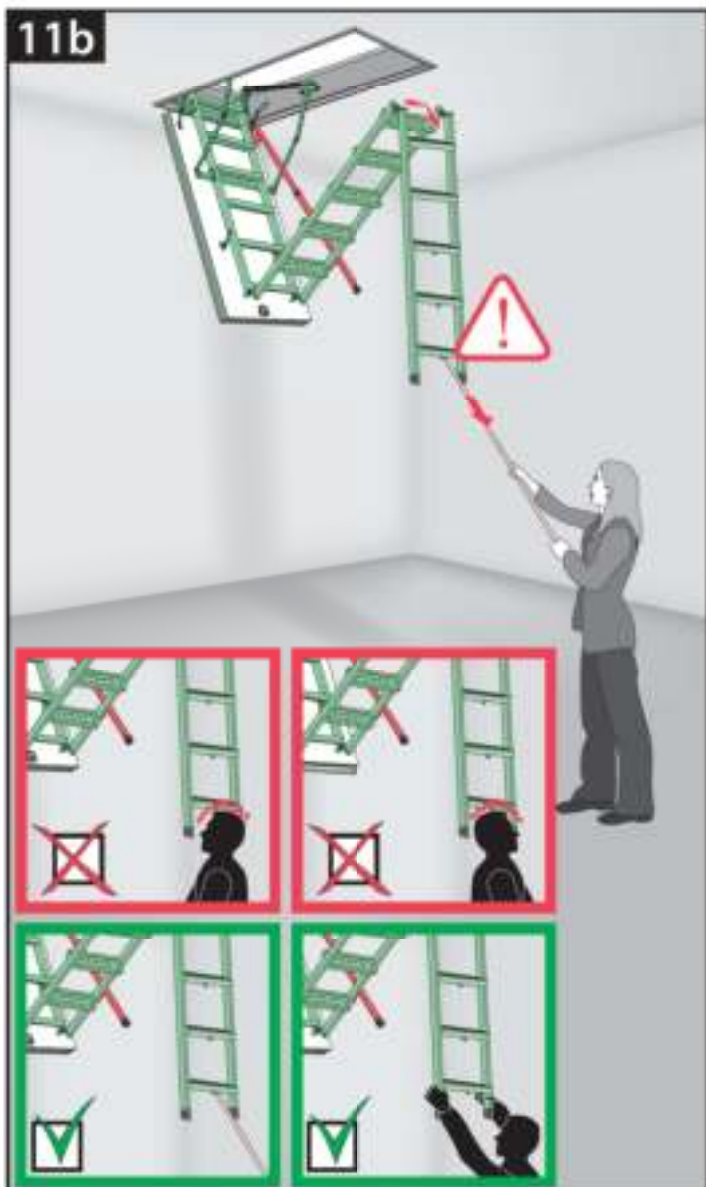

13b

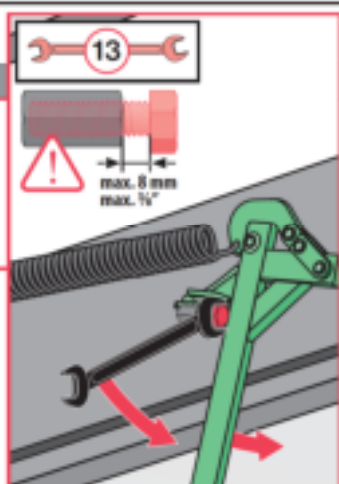

13c

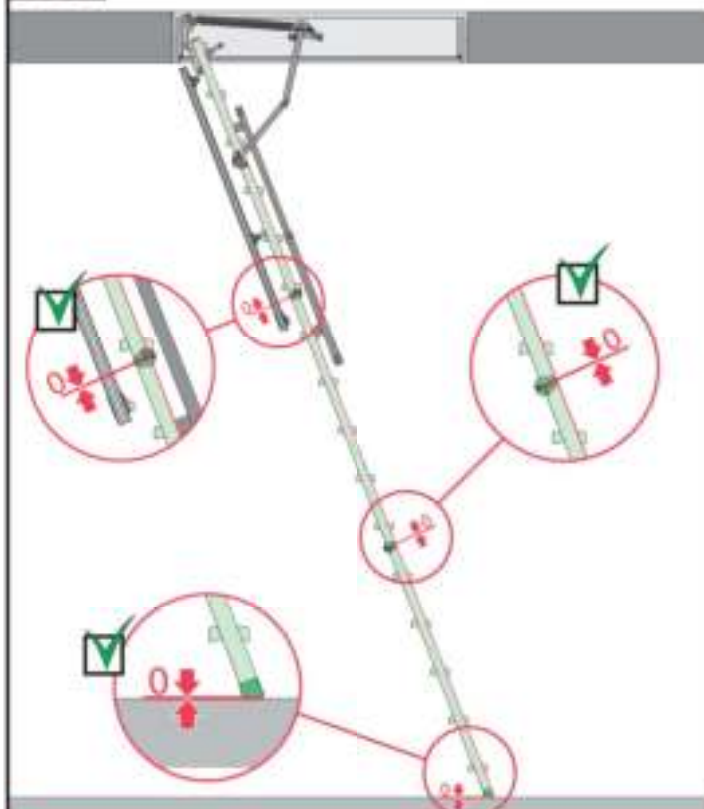

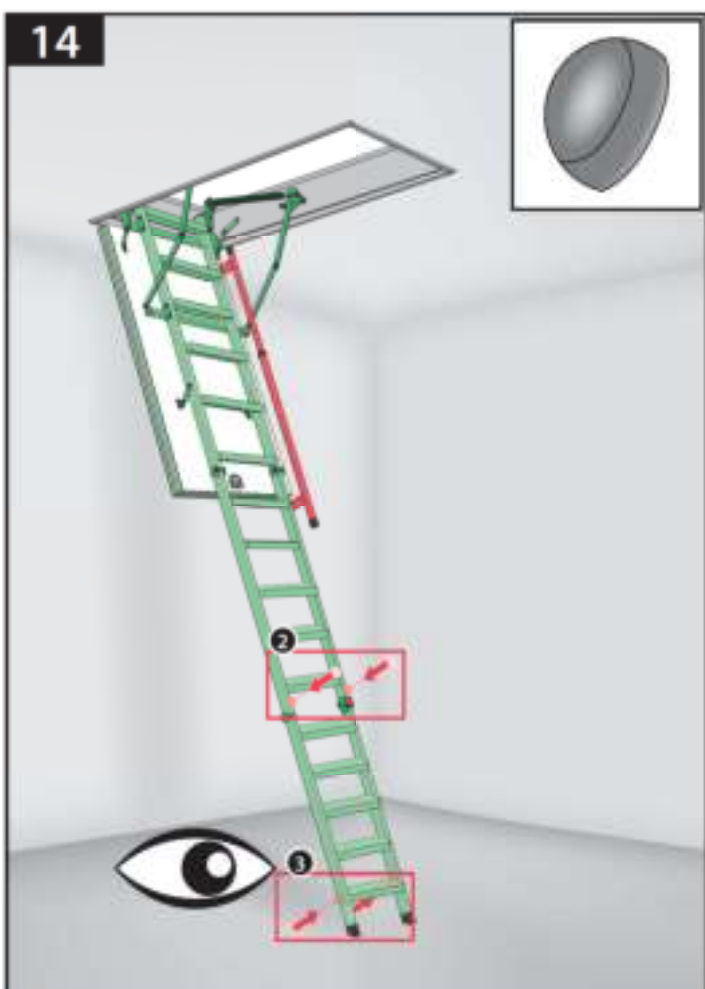

1

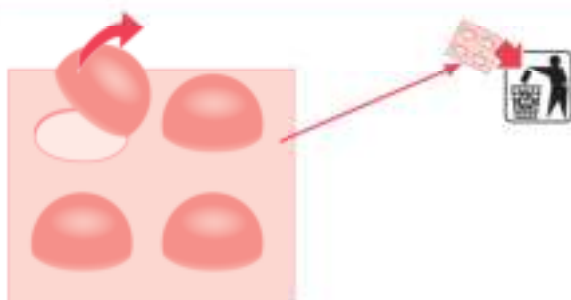

2

~70 mm
~2 3/4"

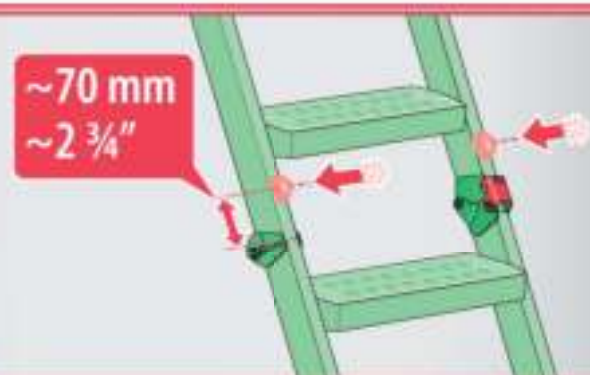

3

~70 mm
~2 3/4"

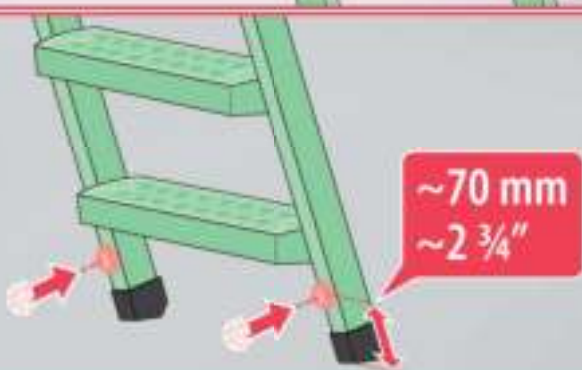

15a

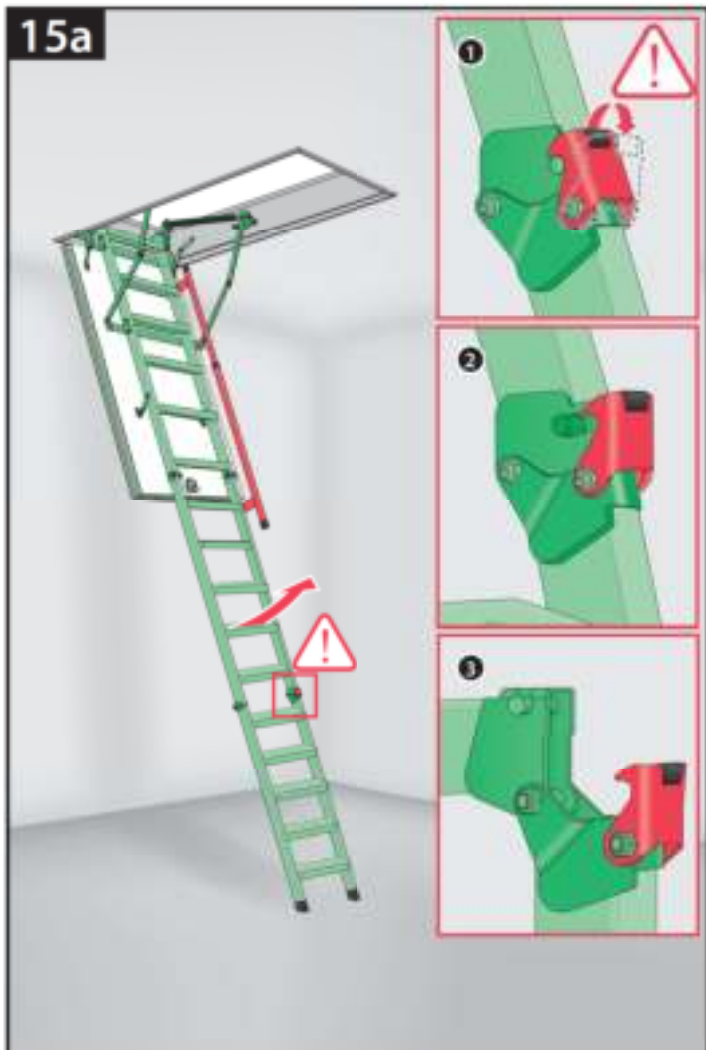

15b

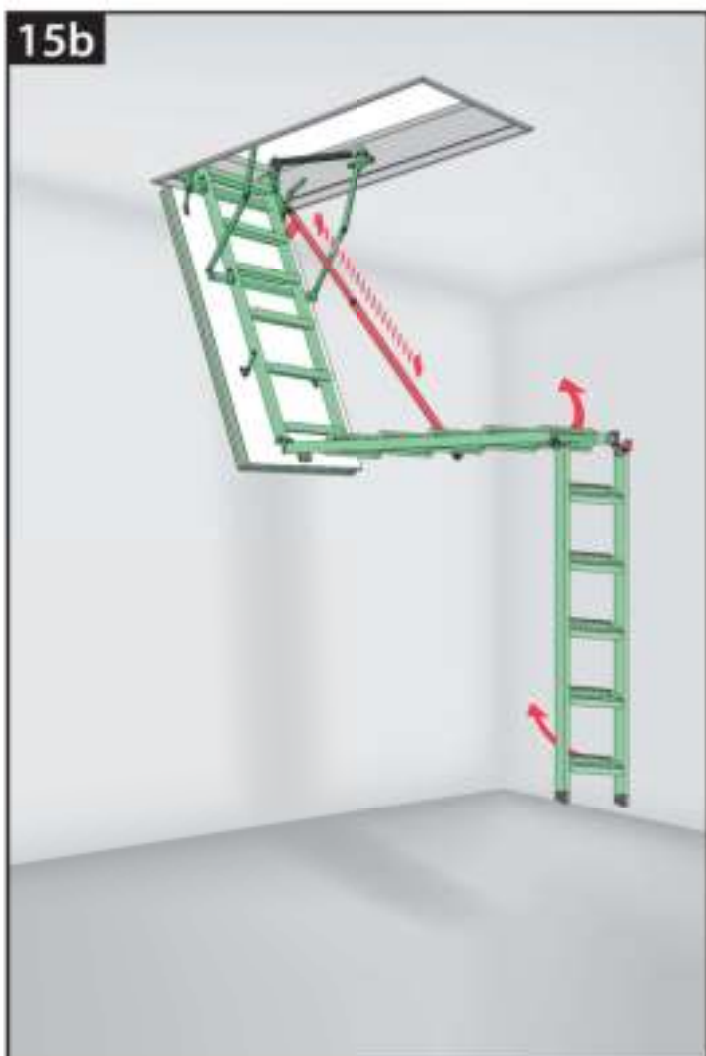

15c

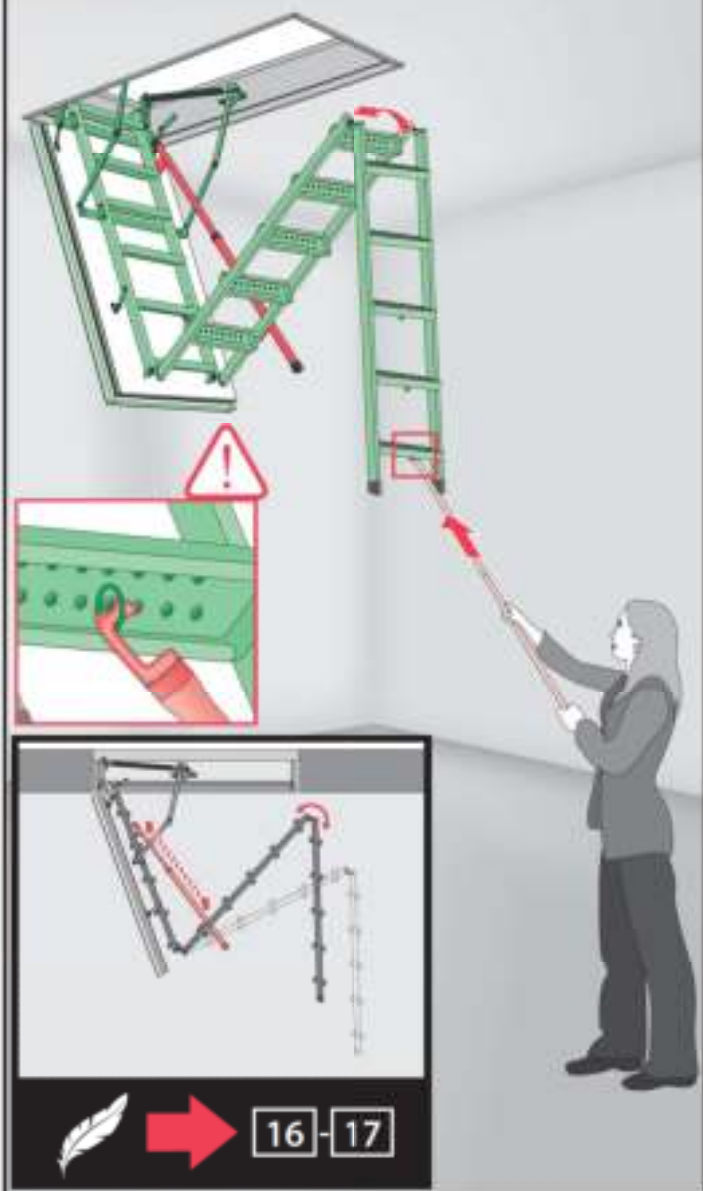

16		
Hmax - 366 cm (12')		Hmax - 366 cm (9'10")
H	H1	H2
366-350 cm 12' - 11'6"	350-325 cm 11'6" - 10'8"	325-300 cm 10'8" - 9'10"



1





2



3



H	-
H1	 x30
H2	 x65



4



5





1



2



3



