

2

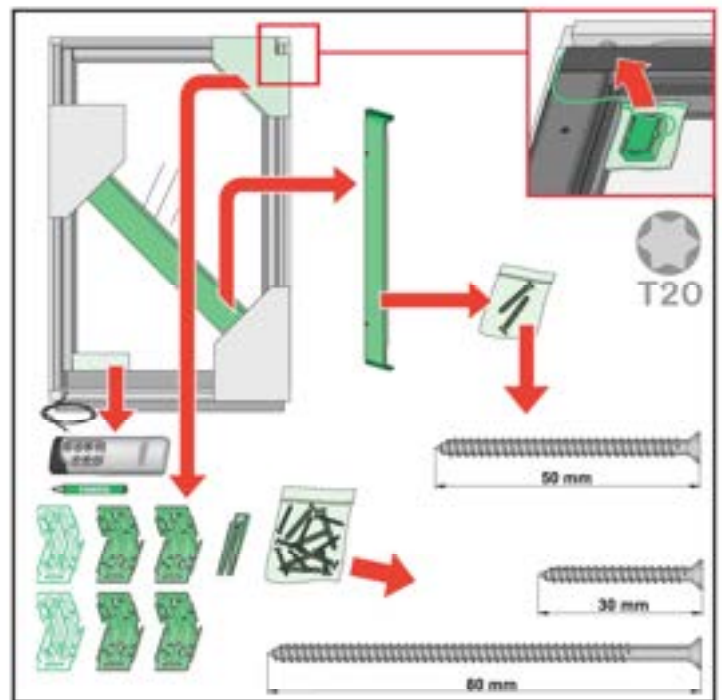

3

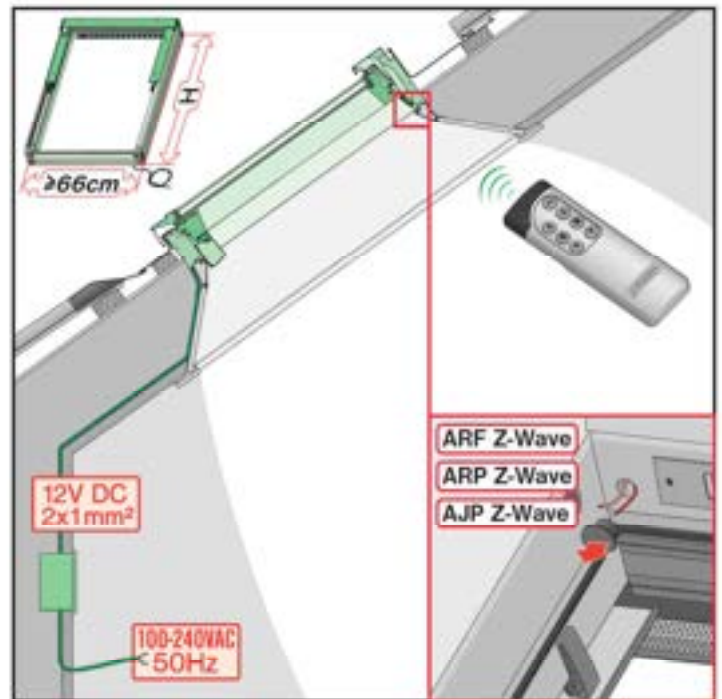
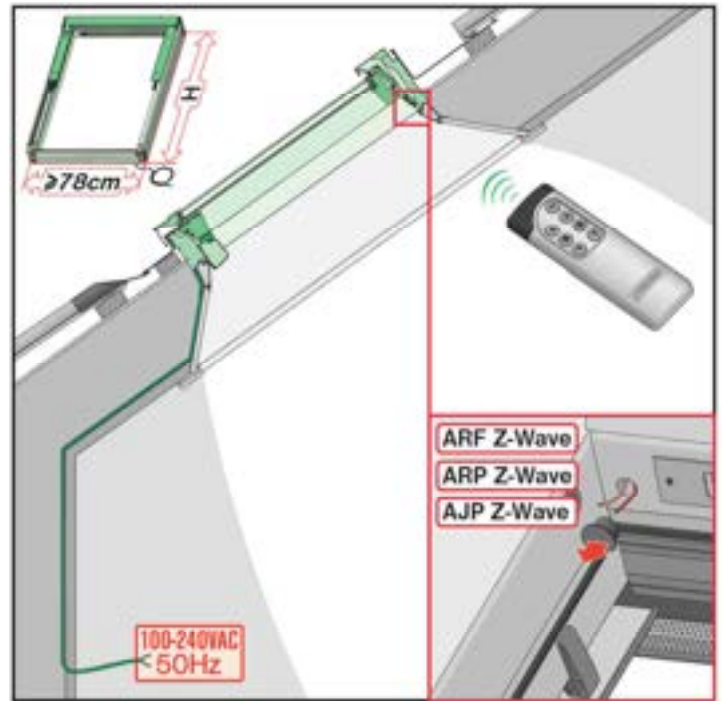
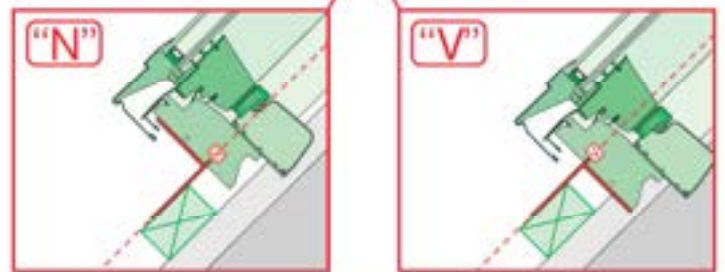
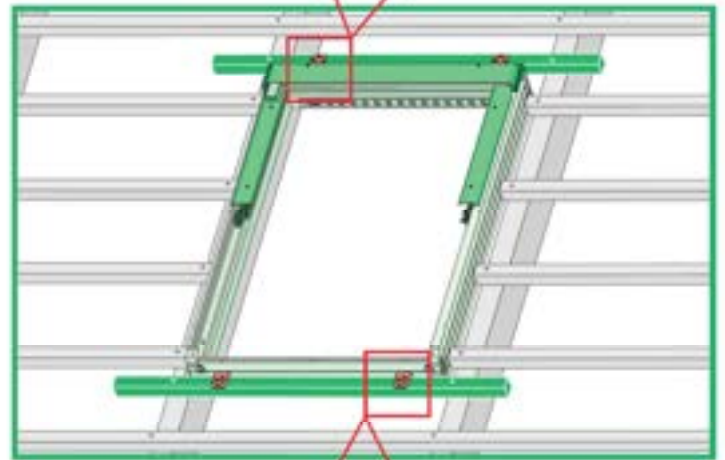
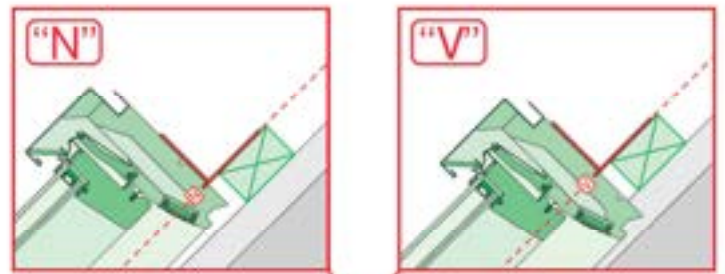
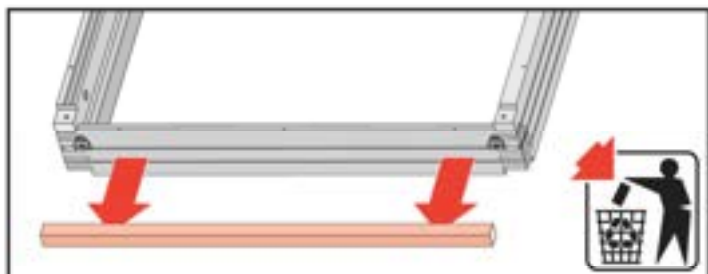
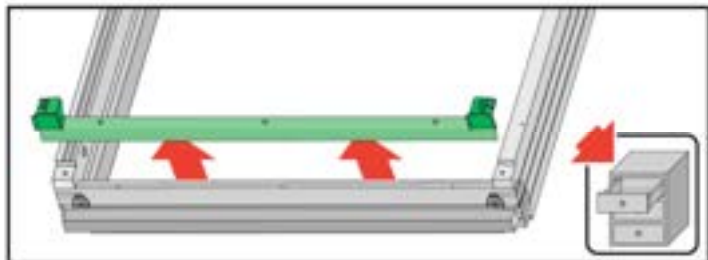
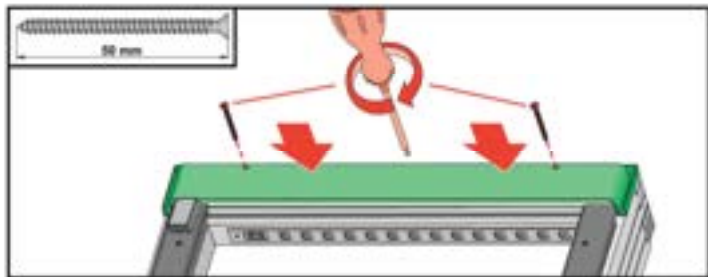
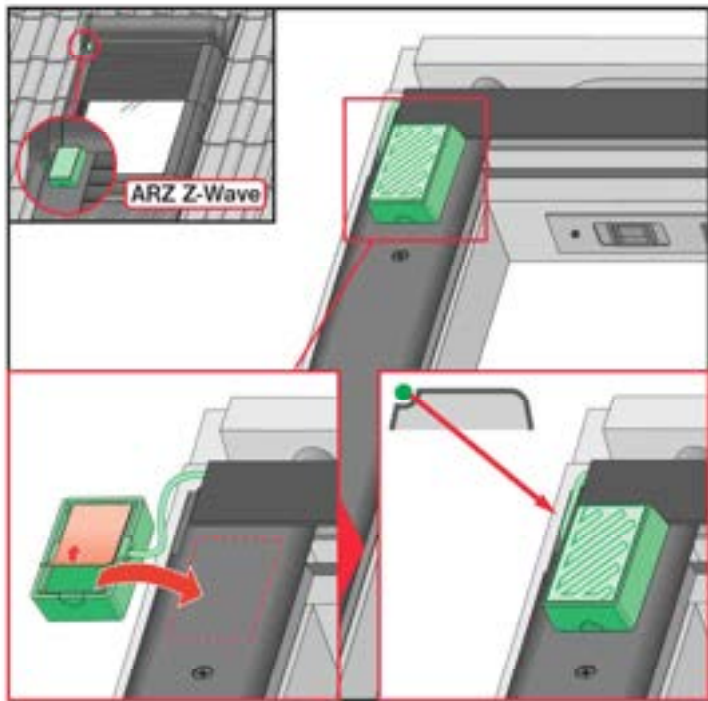
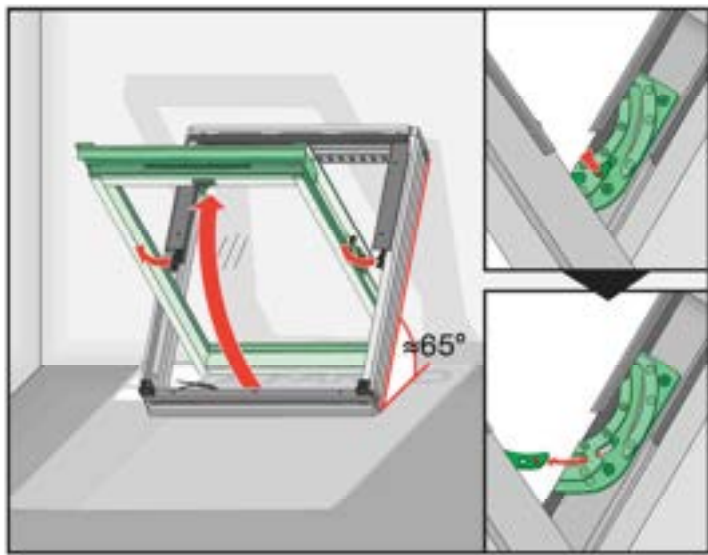

	max 80mm	EHN		
		EHV		
	max 45mm	EZN		
			EVV	
	max 15mm (E) max 8mm (V)	ELN		
			ELV	
	max 5mm	ESN		
			ESV	

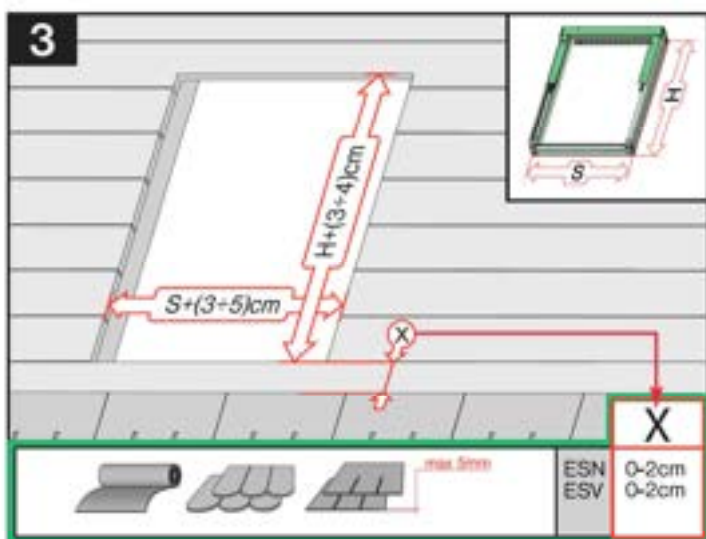
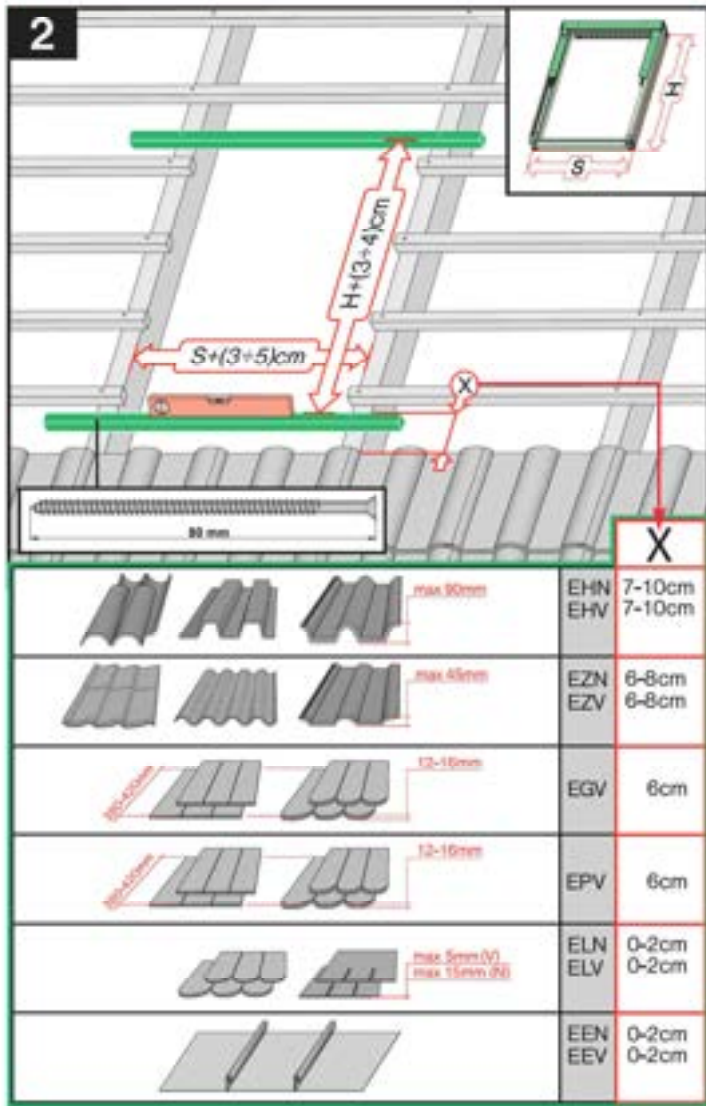
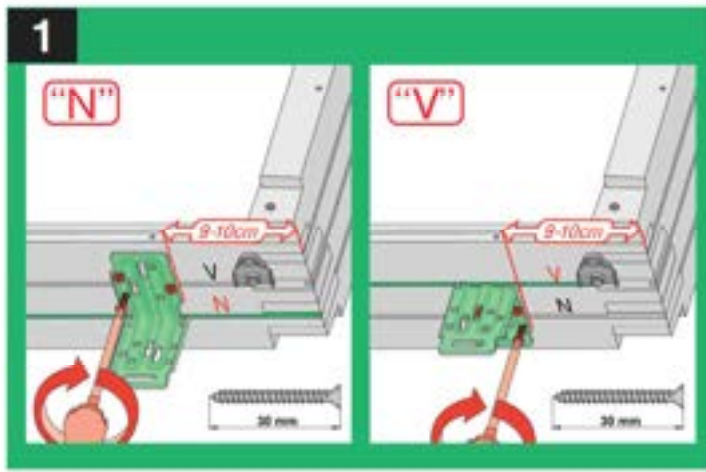

6

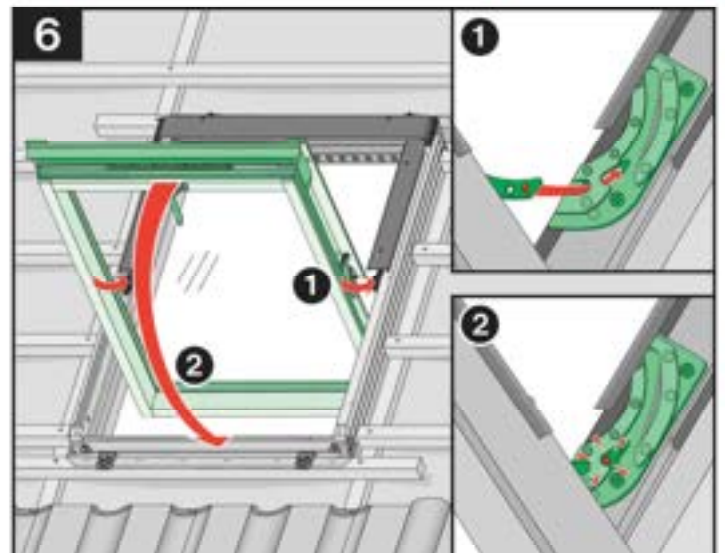
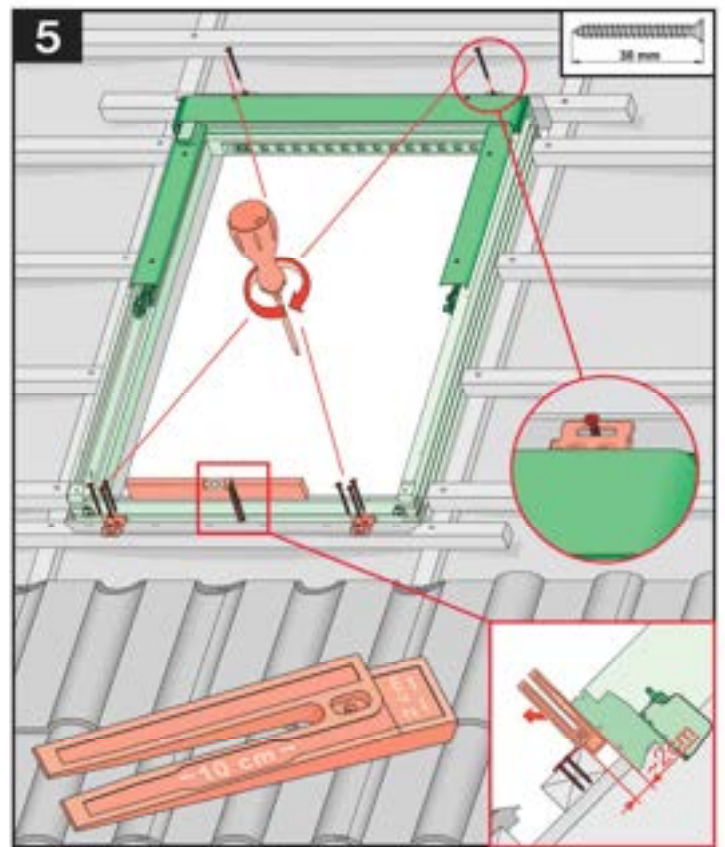
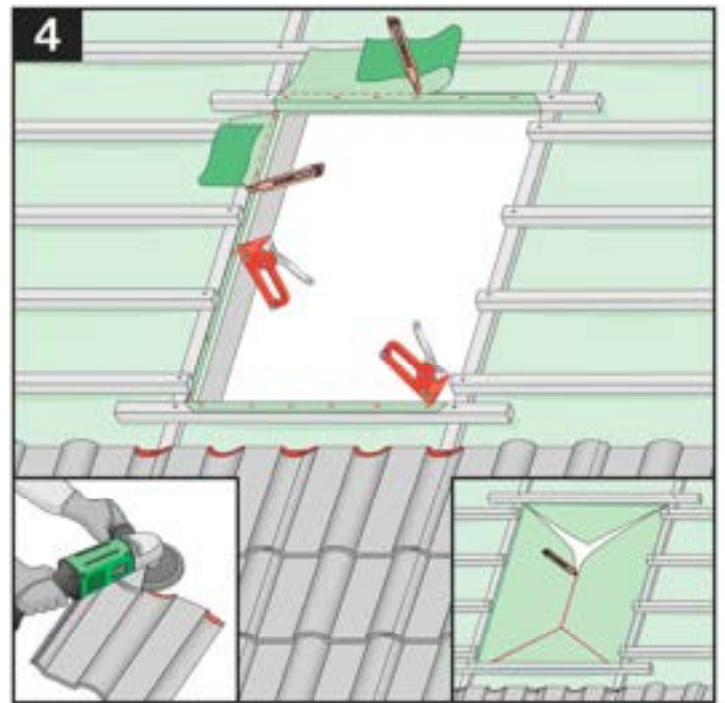

7

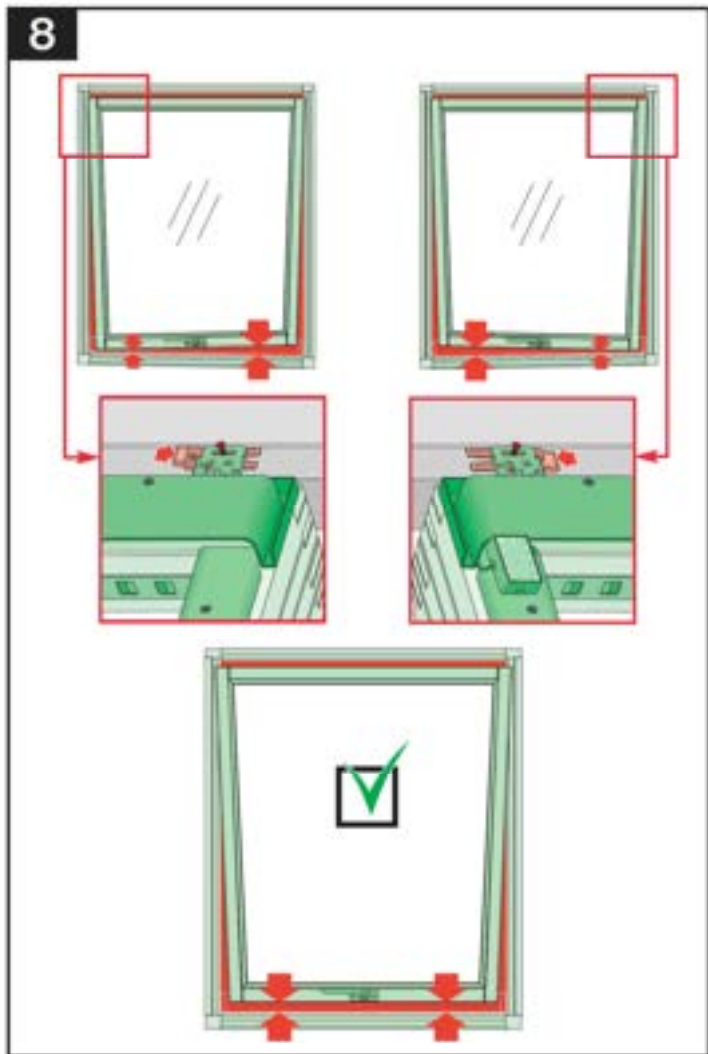
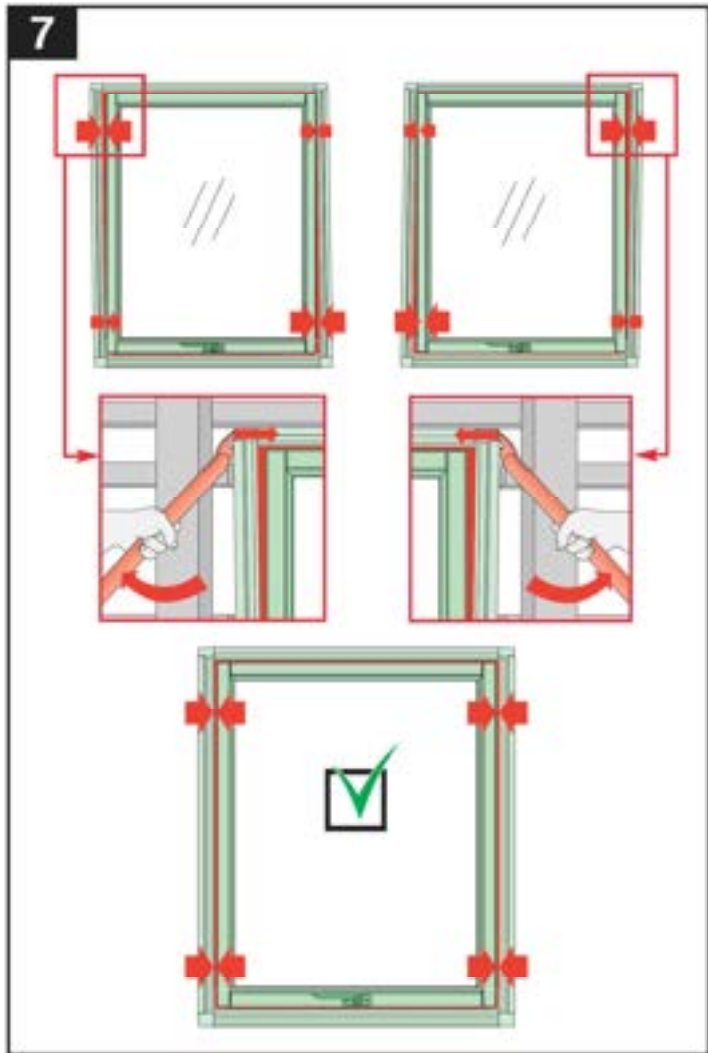



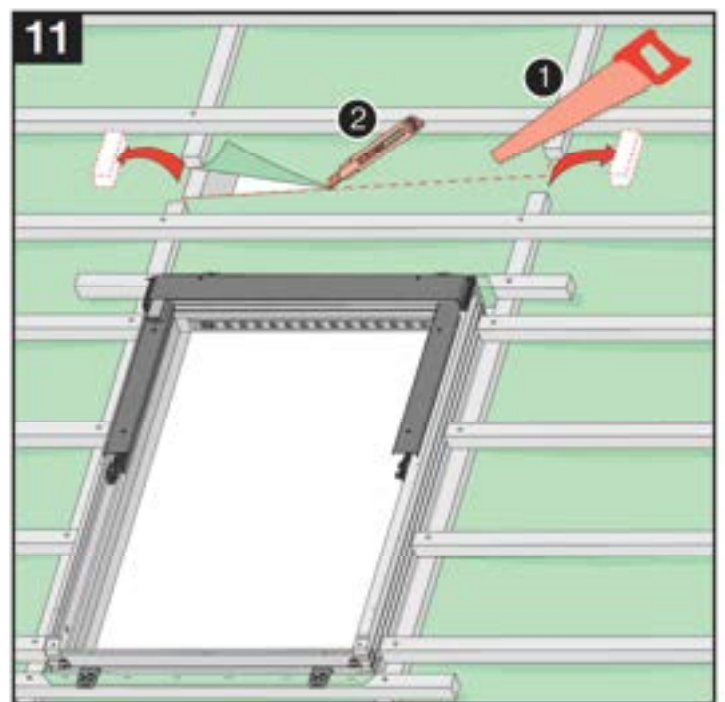
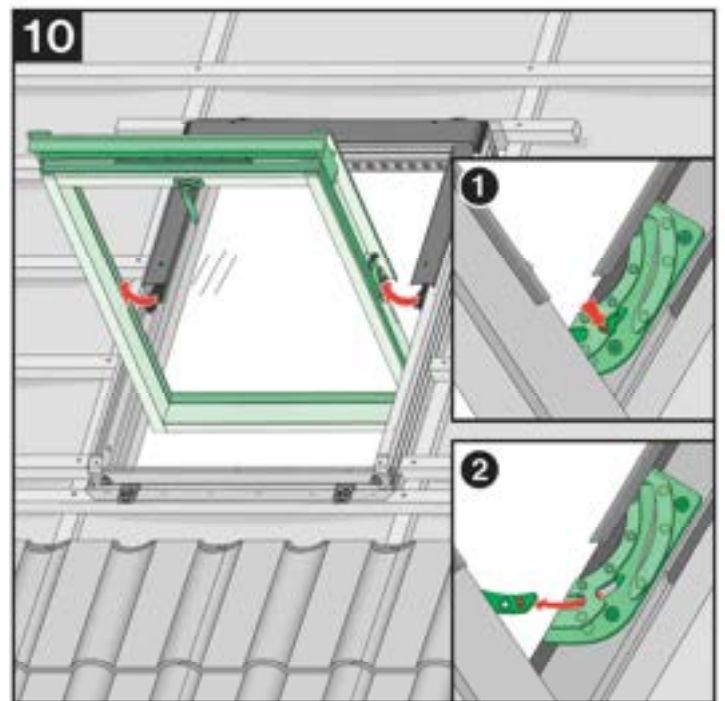
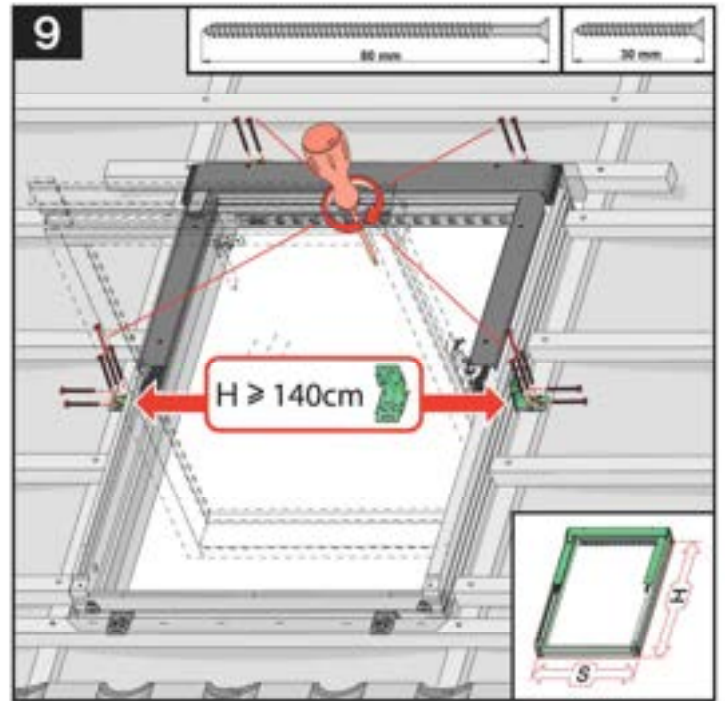



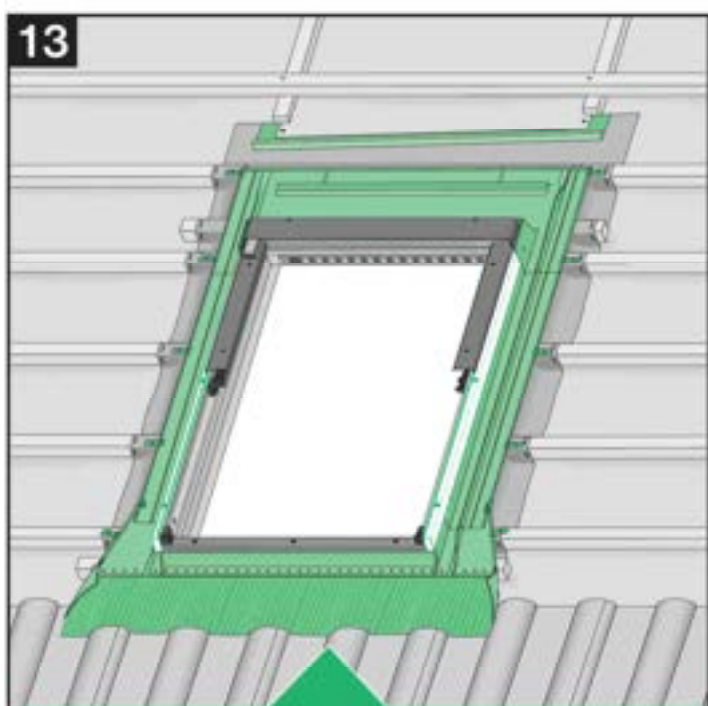
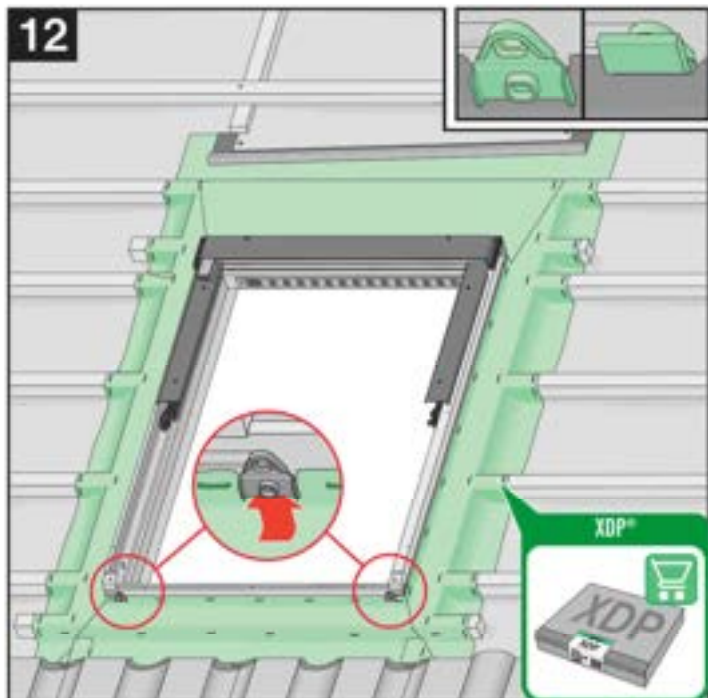

















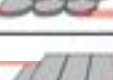

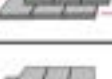







8





9











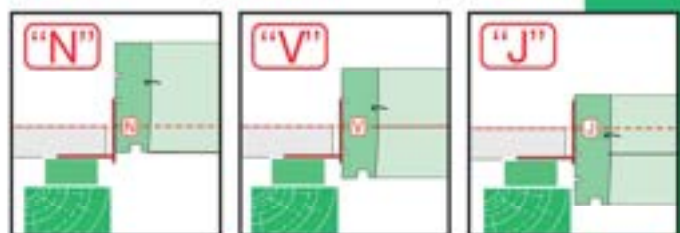
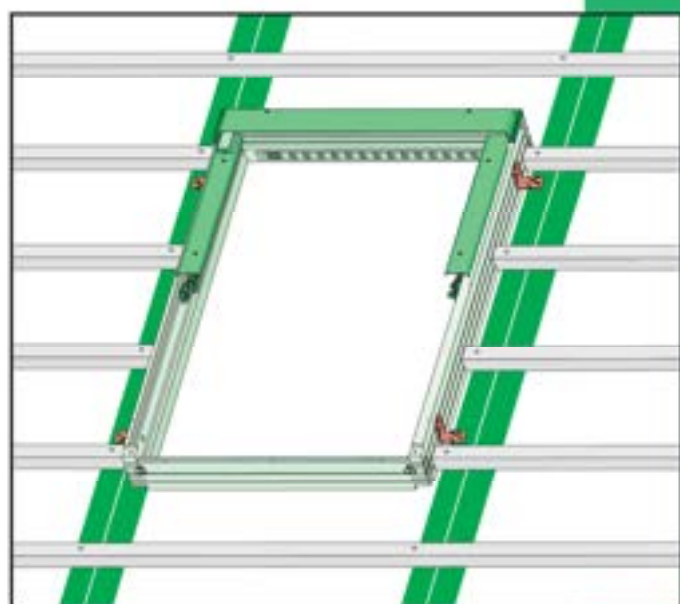

























		max. 60mm	EHN			15°-90°
		max. 60mm	EHV			15°-90°
		max. 60mm	EZN			15°-90°
		max. 60mm	EZV			15°-90°
		max. 60mm	ESN			15°-90°
		max. 60mm	ESV			15°-90°
		max. 60mm	EGV			20°-90°
		max. 60mm	EPV			20°-90°
		max. 60mm	ELN			15°-90°
		max. 60mm	ELV			15°-90°
		max. 60mm	EEN			20°-90°
		max. 60mm	EEV			20°-90°









	max. 60mm	EHN			15°-90°
		EHV			15°-90°
		-	-	-	-
	max. 45mm	EZN			15°-90°
		EZV			15°-90°
		EZJ			20°-90°
	max. 100mm (H) max. 60mm (V) max. 60mm (L)	ELN			15°-90°
		ELV			15°-90°
		ELJ			20°-90°
	max. 50mm	ESN			15°-90°
		ESV			15°-90°
		ESJ			20°-90°

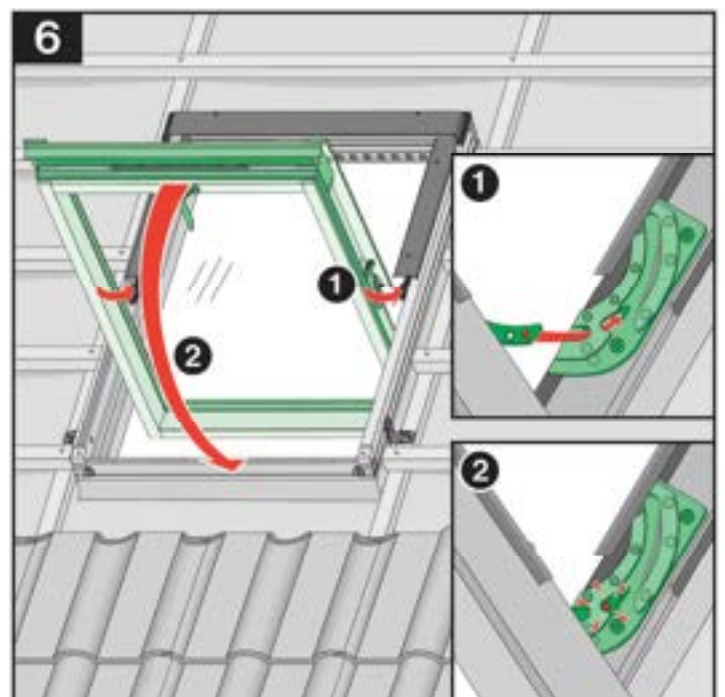
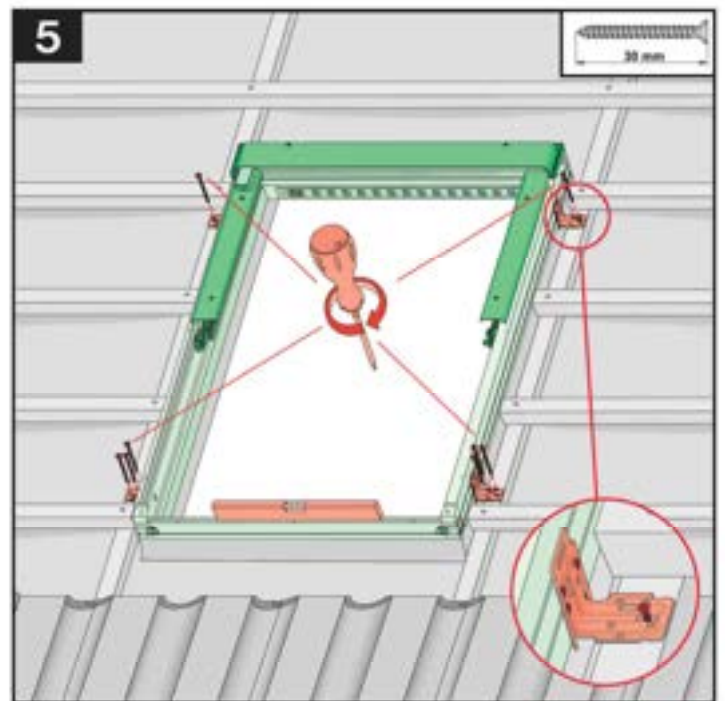
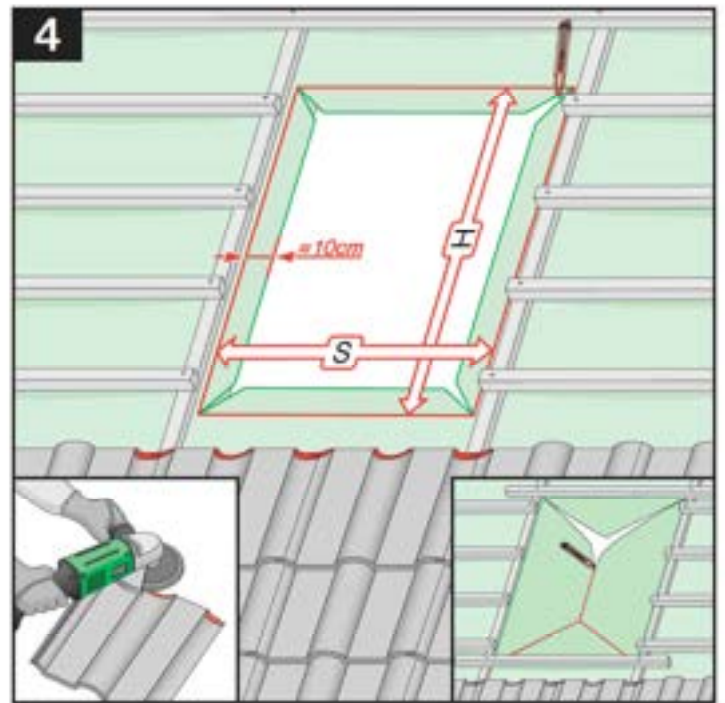
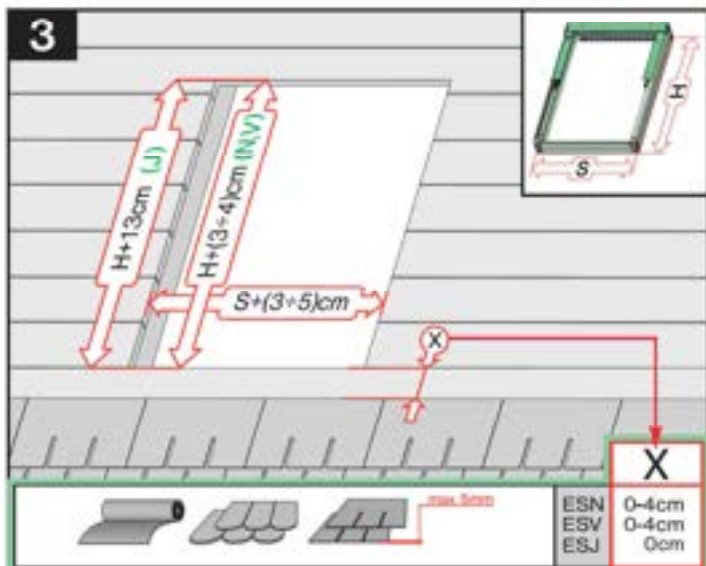
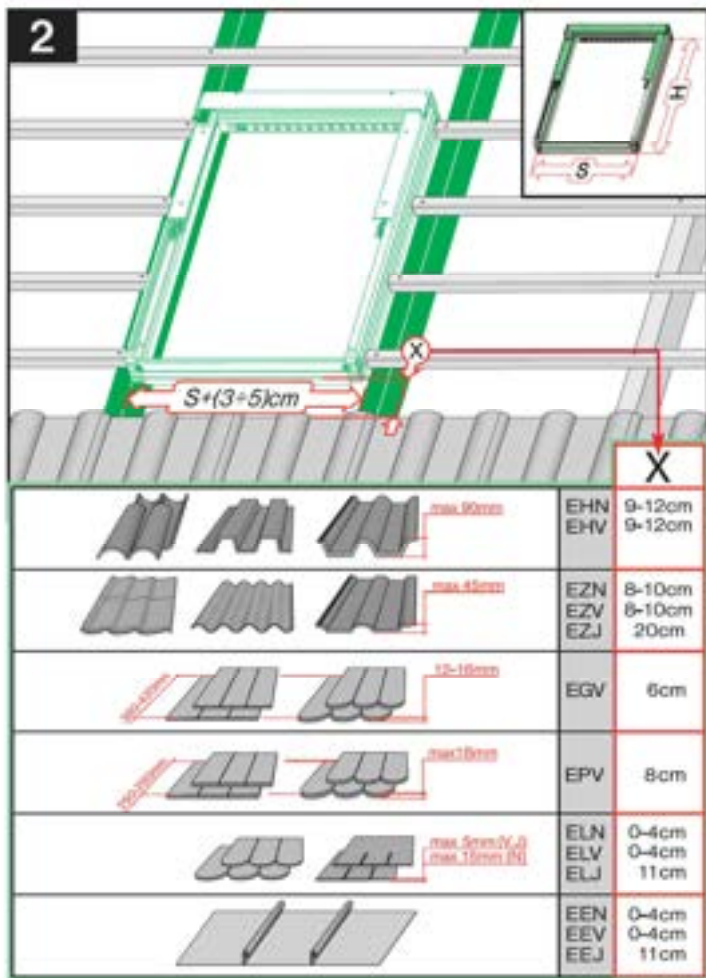
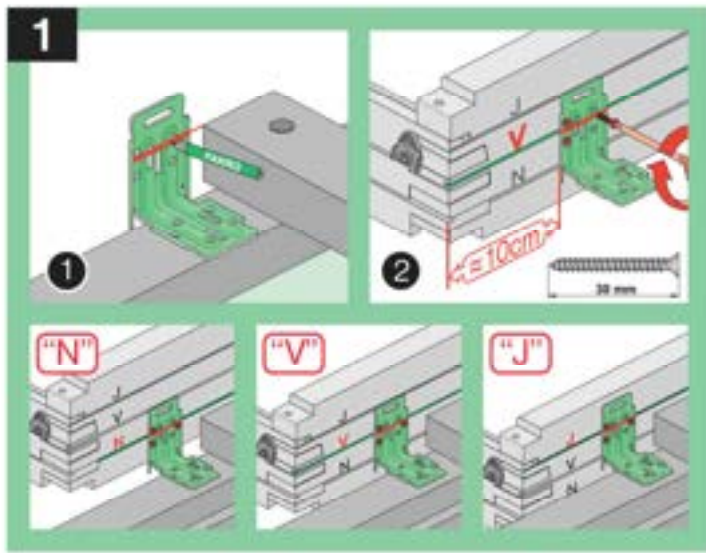

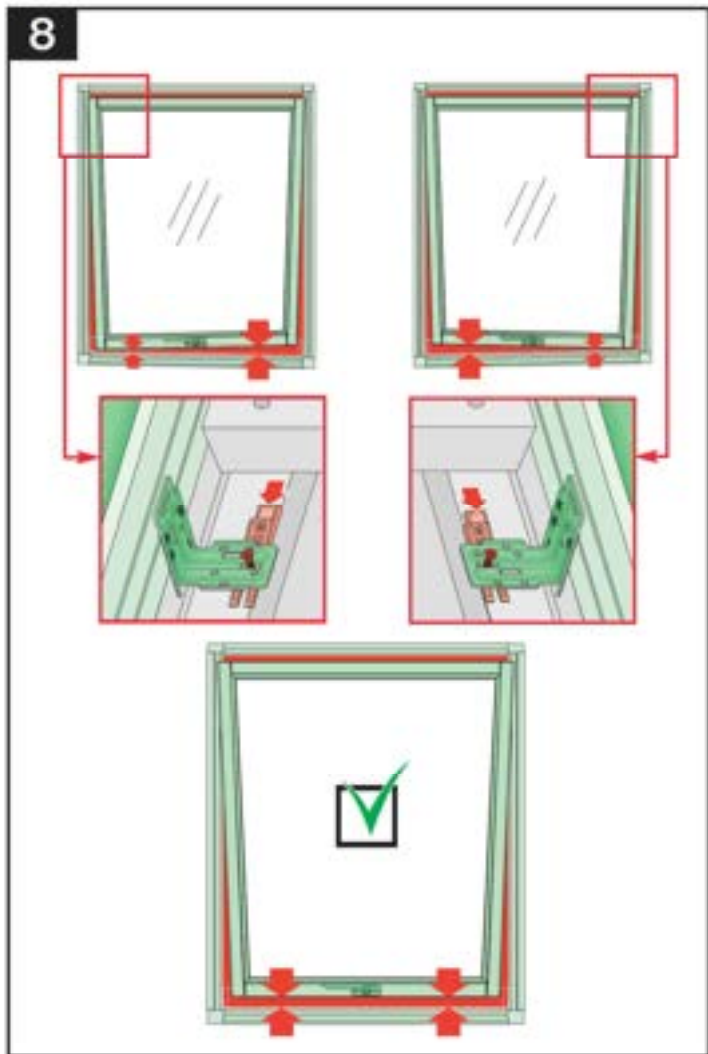
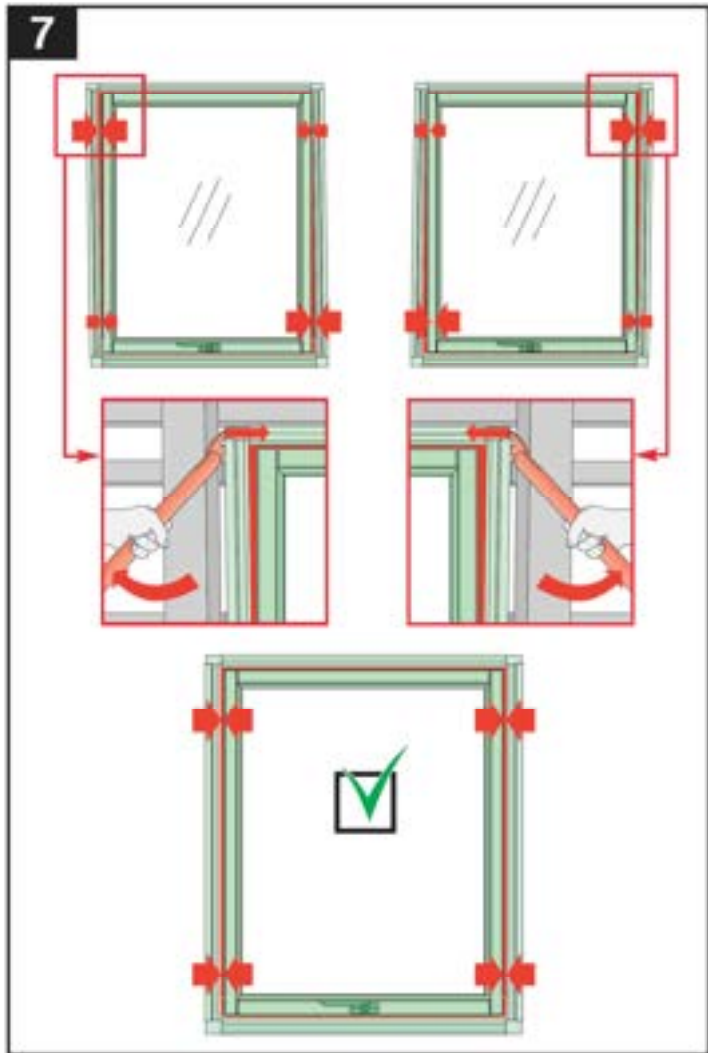

14

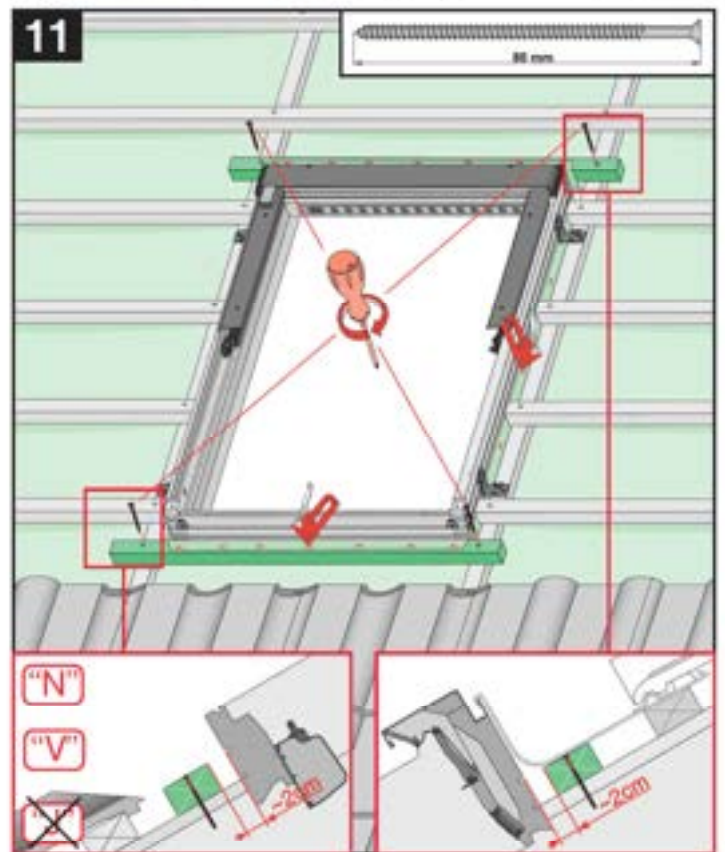
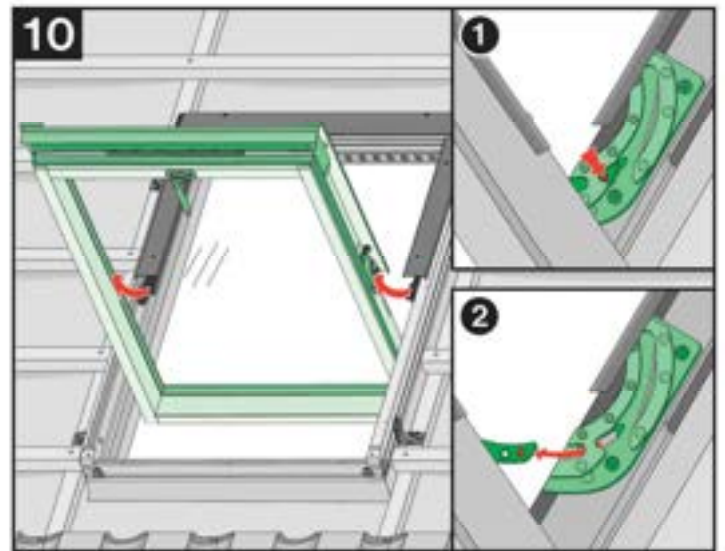
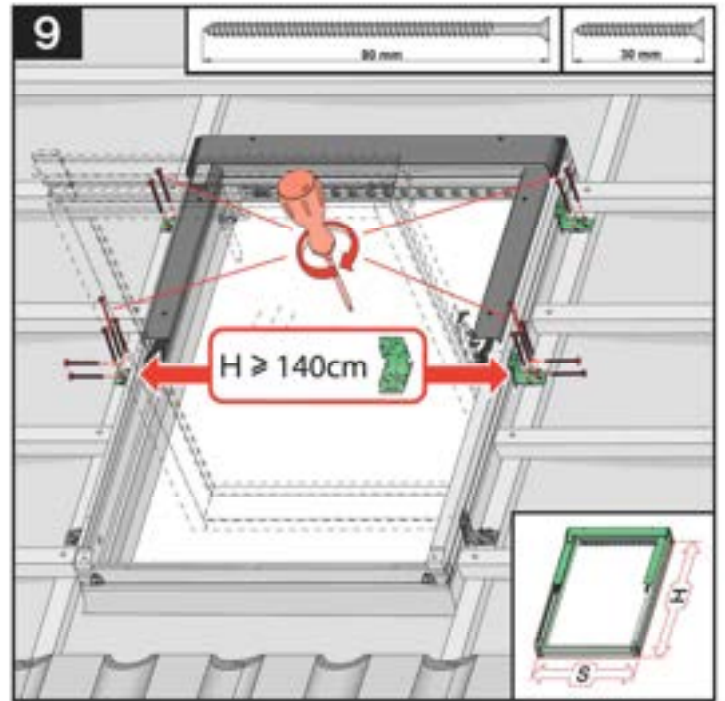

15